

:BILLY

Tavolini



Billy, tavolino dalle numerose funzioni, si distingue per il suo aspetto allegro e giocoso, e ben si adatta ad essere collocato in ogni angolo della casa. La finitura in polietilene lo rende particolarmente pratico e facile da pulire. Il piano superiore bicolore rivela un vano dove riporre piccoli oggetti da tenere sempre a portata di mano.

Design : ANDREA LUCATELLO

BILLY CT407

BILLY LAMP CT408

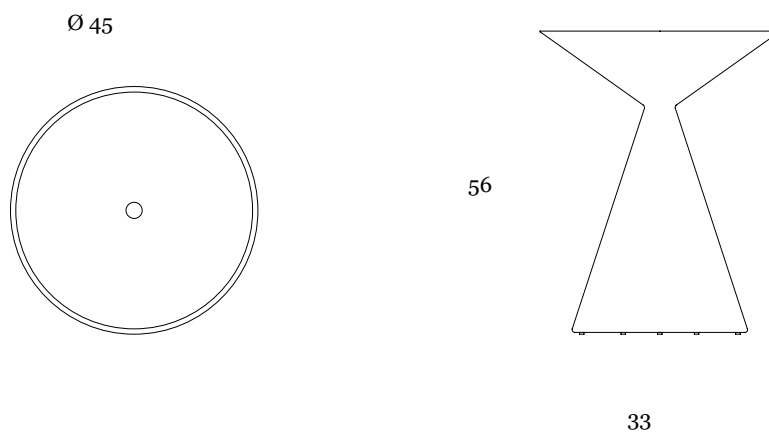

:MATERIALI | MATÉRIAUX | MATERIALS

:POLIETILENE

Polyéthylène | Polyethylene

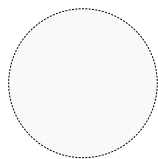

Z01

Bianco

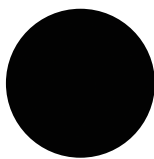

Z02

Nero

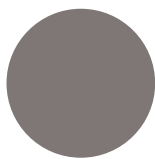

Z03

Tortora

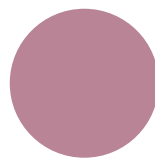

Z05

Rosa

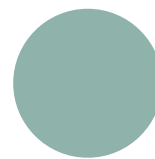

Z07

Azzurro

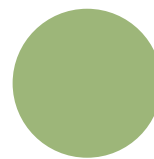

Z09

Verde